

AS A226T flush mounted profiles can easily be applied to all types of floors and load bearing capacities are designed for heavy vehicles or cars depending on the gap inquired. Adjustable interlocking profile and gasket configuration makes it available for very large openings and enables to meet displacements in 3 directions. If inquired, AS A226T can be applied with wall type AS A126 and this dual application brings in a decorative aspect. Profiles are delivered factory-assembled.

- Application Areas** : Indoor & Outdoor / Floor
- Ideal for** : Factories, Warehouses, Car Parks, Shopping Malls, Airports, Residences, Hospitals, Hotels, Public & Commercial Buildings etc.
- Material** : Mill Finish Aluminum (Anodizing optional), TPE Gasket
- Aluminum Alloy** : 6063 AA-USA / EN AW 6063
- Optional Supplies** : Fire Barrier, Waterproof EPDM membrane

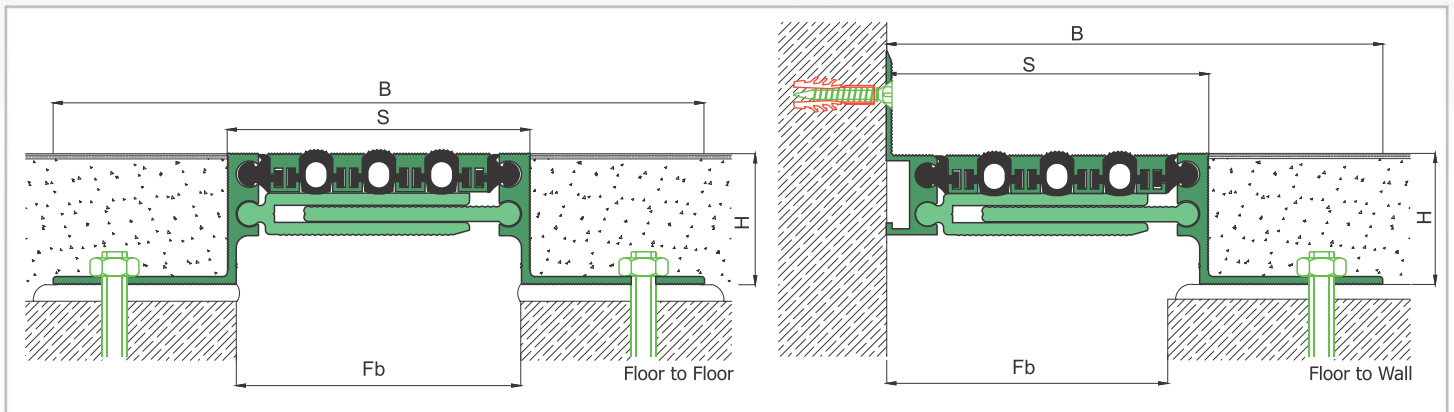

* Visuals are representative and the profile configuration may differ depending on the characteristics requested.

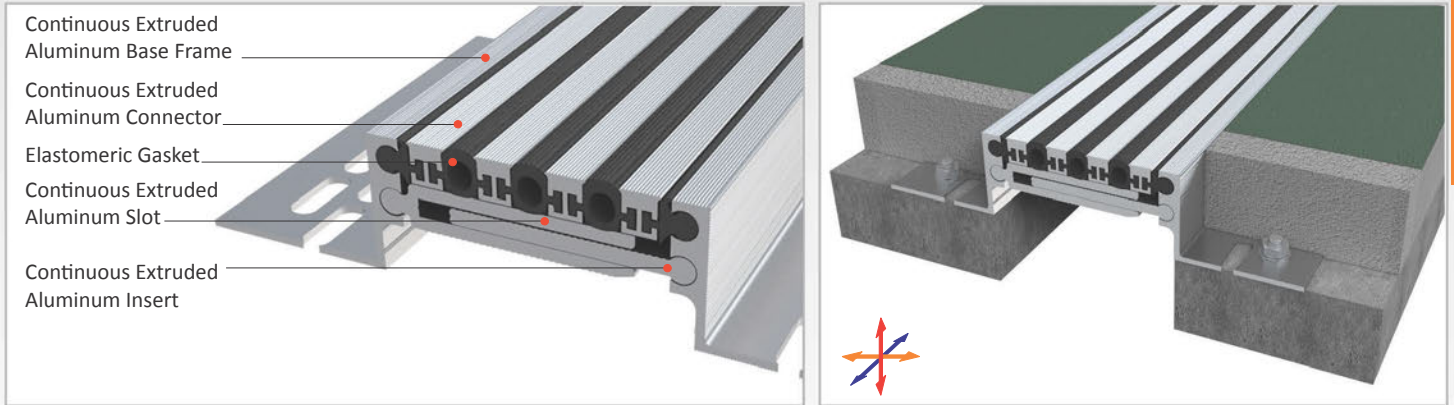

LOCATION	MODEL	GAP (Fb) mm	HEIGHT (H) MM	OVERALL WIDTH (B) mm	VISIBLE WIDTH (S) mm	MOVEMENT (W) mm	LOAD CAPACITY	STANDARD LENGTH (mt)
Floor to Floor	AS A226 T-030	30	35 / 43 / 60	152	38	± 2	70 kN 300 kN	3
	AS A226 T-050	50	35 / 43 / 60	174	60	± 4	35 kN 120 kN	3
	AS A226 T-075	75	35 / 43 / 60	195	80	± 6	25 kN 60 kN	3
	AS A226 T-100	100	35 / 43 / 60	216	102	± 8		3
	AS A226 T-120	120	35 / 43 / 60	238	125	± 10		3
	AS A226 T-140	140	35 / 43 / 60	260	145	± 12		3
	AS A226 T-160	160	35 / 43 / 60	280	165	± 14		3
	AS A226 T-180	180	35 / 43 / 60	300	185	± 16		3
	AS A226 T-200	200	35 / 43 / 60	320	208	± 18		3

Note: Please ask for different sizes

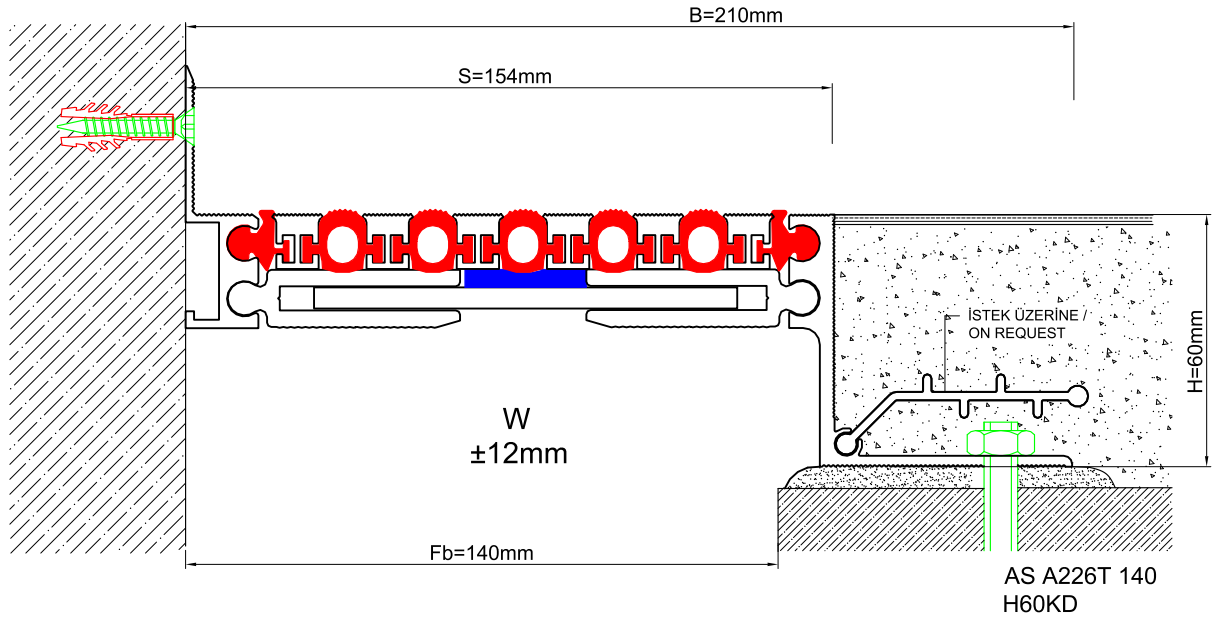
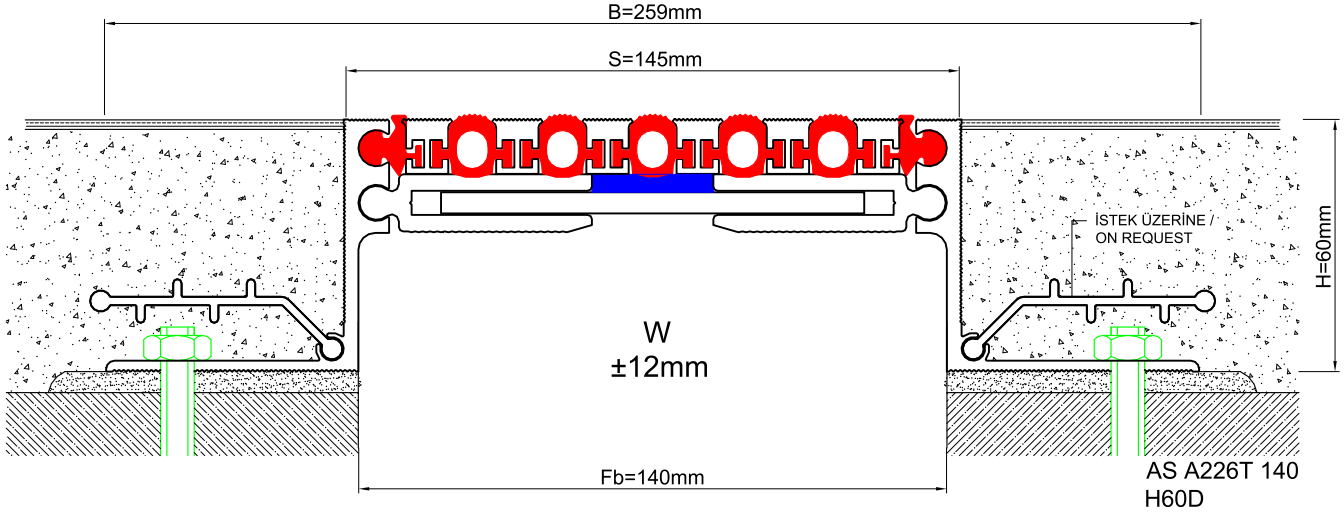

Profil No Profile Number	AS A226T 140	AS A226T 140K
Fb (mm)	140	140
H (mm) yaklaşık approx.	60	60
W± (mm) yaklaşık approx.	±12	±12
Renk Color	Alüminyum: Natürel, Fitiller: Siyah, gri, diğer Aluminum: Natural, Inserts: Black, grey, others	
Malzeme Material	Alüminyum, TPE Termoplastik Elastomer Aluminum, TPE Thermoplastic Elastomer	
Standart Uzunluk Standard Length	3	
Yükleme Kapasitesi Load-Bearing Capacity	